



数据  
传输

检验证书

多功能碳纤维比较卡尺

INSIZE PLUS



1197-600

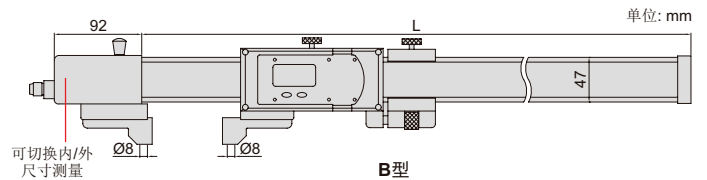
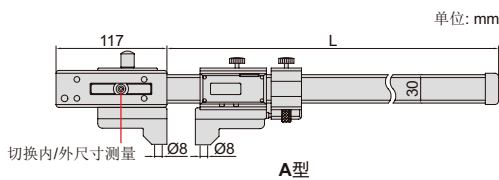

- 符合企业标准
- 用于比较测量内径和外径，在环规或量块上对零后对比测量工件。例如：工件约为200mm，可以在50mm环规上对零，把卡尺拉到200mm后进行测量
- 碳纤维尺身，重量轻，不易变形，温变小
- 卡尺分辨率：0.01mm/0.0005"
- 按键功能：开/关，置零，公/英制转换，设置初始值
- CR2032电池，数据传输
- 可选附件：数据传输线(型号7302-85)，百分表/千分表，各类量爪和测头
- 带生产厂检验证书

型号	测量范围	卡尺精度	百分表精度	L (mm)	重量(g)	备注
1197-600	0-600mm/0-24"	±0.05mm	±0.014mm	750	1900	A型
1197-800	0-800mm/0-32"	±0.06mm	±0.014mm	950	2400	A型
1197-1000	0-1000mm/0-40"	±0.07mm	±0.014mm	1300	2600	B型
1197-1500	0-1500mm/0-60"	±0.11mm	±0.014mm	1800	3100	B型
1197-2000	0-2000mm/0-80"	±0.14mm	±0.014mm	2300	3600	B型

应用

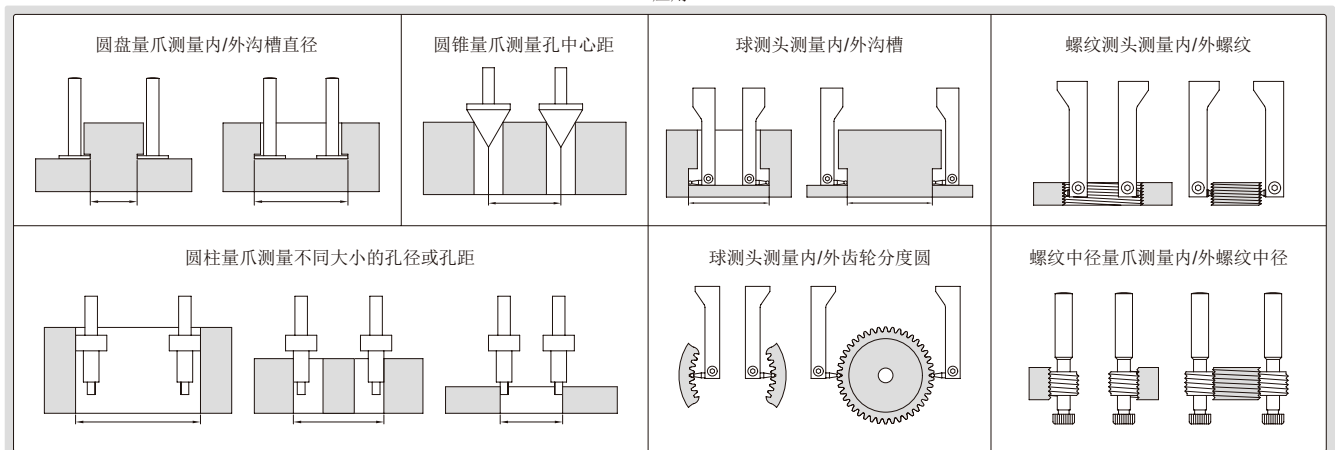

圆盘量爪(选配)

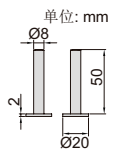

定位块  
(可上下  
移动)



型号

1197-T101

圆锥量爪(选配)

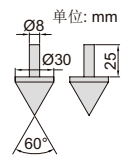

型号

1197-T201

圆柱量爪(选配)

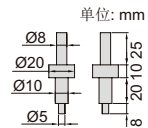

型号

1197-T401

螺纹中径量爪(选配)

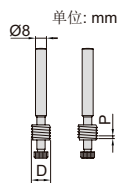

型号	D	P(螺距)	型号	D	P(螺距)
1197-T301	14mm	0.8mm	1197-T306	14mm	2.5mm
1197-T302	14mm	1mm	1197-T307	14mm	3mm
1197-T303	14mm	1.25mm	1197-T308	20mm	4mm
1197-T304	14mm	1.5mm	1197-T309	20mm	5mm
1197-T305	14mm	2mm	1197-T310	20mm	6mm

可换测头量爪(选配)

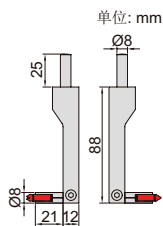

型号

1197-T501

测头座(选配)

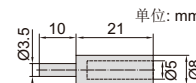

型号

1197-T601

深度限位块(选配)

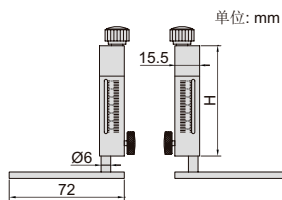

型号	H	备注
1197-T701	69mm	适用于A型卡尺
1197-T702	87mm	适用于B型卡尺

多功能测头7392\* (选配, 详见页码62)



球测头7391\* (选配, 详见页码62)



螺纹测头7381\*, 7321\* (选配, 详见页码62)



\* 当使用这些测头时需选配测头座(型号1197-T601)